

DEPARTMENT OF PUBLIC WORKS

COUNTY OF MONO

ROAD
IMPROVEMENT
STANDARDS

SEPTEMBER 1981

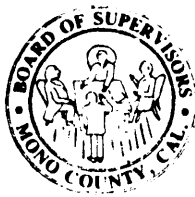

RESOLUTION NO. 81-154

BOARD OF SUPERVISORS, COUNTY OF MONO

1
2
3
4
5
6
7
8
9
10
11
12
13
14
15
16
17
18
19
20
21
22
23
24
25
26
27
28
29

RESOLUTION OF BOARD OF SUPERVISORS, COUNTY OF MONO
ADOPTING MONO COUNTY ROAD IMPROVEMENT STANDARDS.

WHEREAS, Mono County, by and through the Department of Public Works, reviews and approves the plans and specifications for construction of roads to be accepted into the County system; and,

WHEREAS, in connection with the approval of road improvement plans for subdivision maps, the Public Works Department also reviews the plans and specifications for private roads; and,

WHEREAS, the development of road improvement standards was requested by Resolution No. 81-07 of the Board of Supervisors; County of Mono; and,

WHEREAS, said Road Improvement Standards will set forth the minimum road standards in Mono County necessary to provide adequate access to land development projects.

NOW, THEREFORE BE IT RESOLVED, that the attached Mono County Road Improvement Standards will be utilized by the Department of Public Works in approving the design of county road improvements and the design of private roads in connection with the subdivision of land within Mono County.

FURTHER BE IT RESOLVED, the Board of Supervisors, County of Mono, does hereby adopt the Mono County Road Improvement Standards, a copy of which is attached.

PASSED AND ADOPTED THIS 25 DAY OF August, 1981, by the following vote of said Board of Supervisors.

AYES: Supervisors Jencks, Johnson, Maner, Stanford

NOES: None

ABSTAIN: Supervisor Reid

ATTEST: Pat Peigne
Clerk to the Board

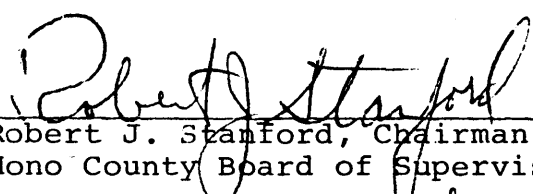
Robert J. Stanford, Chairman
Mono County Board of Supervisors

BY: 
Colleen Stone
Deputy Board Clerk

Approved As To Form:

August 20, 1981

Date

COUNTY OF MONO
STATE OF CALIFORNIA

NEGATIVE DECLARATION

Resolution 81-154/Mono County Road Improvement Standards

Project Title

County of Mono

Project Location

Road Improvement Standards

Project Description

On the basis of the initial study I find that this project will not have a significant effect upon the environment.

DATE: August 27, 1981

Robert M. ...
Planning Director

MITIGATION MEASURES INCLUDED IN THE PROJECT TO AVOID POTENTIAL SIGNIFICANT ADVERSE EFFECTS:

The project will not have a significant impact upon the environment because:

1. Road improvements, maintenance, repairs and etc. within existing right-of-way are categorically exempt as a Class I, Exemption
2. Projects requiring dedication or offers of right-of-way would be subject to individual CEQA review as discretionary projects.

ADOPTED AND ORDERED FILED THIS 27th DAY OF August 19 81

BOARD OF SUPERVISORS

PLANNING COMMISSION

James G. ...
Chairman
Planning Commission

PUBLIC HEARING HELD: August 27, 1981

RECEIVED

SEP 1 1981

MONO COUNTY
ROAD DEPARTMENT

MONO COUNTY ROAD IMPROVEMENT STANDARDS

CONTENTS

	Page No.
Assessment District	1
Design Standards (Chart)	7
Engineer Plans	1
Maintenance Districts	2
Mitigation Agreements	2
Road Categories and Typies	3
Road Design	5
Snow Stakes	8
Street Signs	8
Appendix A - Typical Plans	

APPENDIX A

INDEX

	<u>Plate No.</u>
Backfill	15
Barricade	20
Cul-de-Sac	17
Curb and Gutter, etc.	14
Dikes, etc.	13
Intersections	16
June Lake Streets	
Arterial/Commercial	12
Collector/Residential	11
Mammoth Streets	
Arterial	7
Collector/Commercial	6
Residential	5
Manholes, etc.	19
Parking	18
Private Streets	
Class I	1
Class II	2
Class III	3
Class IV	4
Standard County Roads	
Arterial/Commercial	10
Residential	9
Rural	8

MONO COUNTY ROAD IMPROVEMENT STANDARDS

GENERAL

Purpose: The road improvement standards and requirements contained in this document shall be the minimum required to provide adequate access to land development projects. These standards shall apply to all road improvements required under the provisions of the Mono County Code and are adopted by reference as though contained wholly therein. All Mono County Code provisions relative to this document shall apply as though contained wholly herein except this document shall take precedent over conflicts.

Conformance to General Plan: The design, layout, and other aspects of road improvements for subdivisions shall conform to these improvement standards, general or specific plans, and in all cases shall provide for the advantageous development of the general planning area within which the subdivision lies.

Engineering Certification: All improvement plans and the specific details and specifications thereof shall be prepared by, or under the direction of, and signed by, a Civil Engineer licensed in the State of California and shall be subject to the review and approval of the County Director of Public Works prior to construction of the improvements. It is recognized that there may be situations where these standards cannot be reasonably applied or situations not addressed herein. In either case, it shall be the sole responsibility of the Department of Public Works to exercise sound engineering judgment in approving alternate proposals in these situations.

Assessment Districts: Formation of an assessment district to provide for construction of improvements in a new subdivision is prohibited.

Maintenance Districts: If the roads constructed within a subdivision are to remain private, then a maintenance entity shall be formed to insure continued maintenance on the road system. The entity shall be formed in accordance with the Standard Maintenance Agreement on file with the Department of Public Works. The subdivider may be required to annex to an adjacent existing maintenance entity.

Mitigation Agreements: In situations where the County determines that incremental road improvement should be deferred or supplemental road improvement is necessary, the developer shall be required, as a condition to project approval, to enter into a mitigation agreement. Such agreements shall provide for contributions of funds equal to the estimated cost of the incremental improvements deferred, such funds to be deposited in an interest bearing account in the name of the road involved; or, in cases where supplemental improvements are required, the County may enter into a reimbursement agreement with the developer installing such supplemental improvements.

Offsite Access: The subdivider shall provide adequate right-of-way and shall improve any offsite roads, required for the subdivision, to the requirements specified in these standards. Adequate right-of-way is defined as right-of-way of sufficient width to contain the entire road prism including cut and fill slopes and the minimum as defined elsewhere herein.

Road Drainage: Road drainage concerns shall receive design consideration as shown herein and as approved by the Department of Public Works. Road drainage shall be addressed on all improvement plans, and shall, as a minimum include such drainage provisions as are included on the applicable standard drawings attached hereto.

Accepted For Maintenance: When roads are constructed to county standards, the current county policy is that they may be accepted for maintenance by the County.

ROAD CATEGORIES AND TYPES

Road Categories: The four categories are: Residential Drives, Mammoth Lakes, Standard County, and June Lake. These four categories separate the road standards in Mono County based on snowfall, freezing, runoff, topography, development trends, general road maintenance concerns, and traffic volumes and types.

Residential Drives-are a developer option for rural areas of the county, and serve minimum numbers of lots in a rural setting. The County may disapprove the use of private drives if a finding of overriding public concern is made.

Mammoth Lakes-are roads designed for use in the Mammoth Lakes area, an urban area in a high mountainous setting.

Standard County- are roads designed for general use in areas of Mono County other than June Lake and Mammoth Lakes.

June Lake-are roads designed for use in the June Lake area, an area mixed with old subdivisions, mostly residential, and minor urbanization. An area nestled below high mountainous ridges with limited developable land.

Road Types: Road types shall conform to the appropriate descriptions listed below and the corresponding typical sections and conditions in Appendix A.

Residential Drive-Class I: This shall be a privately owned and/or maintained road which may serve a maximum of four (4) residential lots, 1/3 acre or greater in area. This road is designed for private residential use in terrain that has flat to rolling topography; where native soils evidence an ability to resist erosion. This road is additionally intended for use in areas which receive minimal or no snowfall (elevations below 6,000 feet msl).

Residential Drive-Class II: This shall be a privately owned and/or maintained road which may serve a maximum of four (4) residential lots 1/3 acre or greater in area. This road is designed for private

residential use in terrain that has flat to mountainous topography; where native soils cannot support local traffic loads, or a road that is not hard-surfaced, or where native soils have inability to resist erosion. This road is additionally intended for use in areas which receive above minimal snowfall (elevation above 6,000 msl).

Residential Drive-Class III: Same as Class I, except this road may serve six (6) or less residential lots 1/3 acre or greater in area.

Residential Drive-Class IV: Same as Class II except this road may serve six (6) or less residential lots 1/3 acre or greater in area.

Mammoth/Residential: This may be a county maintained road and serves any number of residential lots.

Mammoth/Collector/Commercial: This shall be a county maintained road which functions as a residential collector or provides access into and/or through a commercial area within the Mammoth Lakes area.

Mammoth/Arterial: This shall be a county maintained road designated by the County as an arterial roadway in the Mammoth Lakes area.

Standard County Road/Rural Subdivision: This may be a county maintained road serving any number of residential lots 1/3 acre or greater in area. Any roadway drainage concerns shall receive design consideration as approved by the Department of Public Works.

Standard County Road/Residential: This may be a county maintained road serving any number of residential lots.

Standard County Road/Arterial/Commercial: This shall be a county maintained road designed by the County as an arterial roadway or which provides access into and/or through a commercial area.

June Lake/Collector/Residential: This may be a county maintained road serving any number of residential lots and shall function as a residential collector in the June Lake area.

June Lake/Arterial/Commercial: This shall be a county maintained road designated by the County as an arterial roadway or which provides access into and/or through a commercial area.

Road Design Standards: Also refer to Sneet 7

Right-of-Way: The minimum right-of-way width for roads to be maintained by the County shall be sixty feet unless otherwise shown herein. Rights-of-way may be a combination of fee simple or easement as situations dictate and as approved by the Department of Public Works. Snow storage easements may be used outside the roadway prism to make up the total required right-of-way in areas where fee simple or road easements cannot be obtained.

Structural Section Design: Roads shall be designed with a minimum structural section as shown or with the data given on the typical sections herein. Traffic Index Values may be increased based on actual analysis but in no case shall T.I. Values be decreased from those given. Unless specifically approved by the Department of Public Works, asphalt surfacing shall be 1/2" maximum, AR 4000 plant mix; and base shall be Class 2 Aggregate Base, all as set forth in the State of California Department of Transportation Standard Specifications.

Drainage: Roadway drainage shall be designed with considerations for the amount of runoff, erosion protection, and maintenance of facilities.

Geometrics and Profiles: The following standards for the design of geometrics and profiles for proposed improvements shall govern the preparation of plans for such improvements.

A. Grades and Cross Slopes:

1. Minimum grade on new streets shall be 0.50 percent.
2. Minimum grade of gutter sections constructed on existing street shall be 0.50 percent.
3. Cross slope to crown on new streets shall be 2.0 percent. (Intersections and super-elevations excepted).
4. Maximum grade on new streets shall be 15 percent. However, all slopes in excess of 10 percent require the approval of the Director of Public Works. If County snow removal is contemplated, the desirable maximum grade should be 9 percent. In order to be acceptable to the County for snow removal, the slope should not exceed 9 percent.

5. The grade of the pavement surface across an intersection shall not be more than + 2 percent.
6. The gradient of any street entering an intersection shall not be more than 2 percent within a distance of 30 feet from the near curb line and/or edge of shoulder of the major crossing street.

B. Vertical Curves: Changes of grade in the vertical alignment of the street shall be made with parabolic vertical curves. The length of vertical curve required shall be determined by the design speed and as approved by the Department of Public Works. The maximum grade differential permitted without a vertical curve is 1 percent (1%).

C. Horizontal Curves: Changes in direction of the streets shall be made with horizontal circular curves, with the edges of the pavement and curb lines parallel to and equi-distant from the centerline of the right-of-way. The radius of curvature in the centerline of the street shall conform to County minimum standards for design speed.

D. Cul-de-Sacs: The minimum radius for right-of-way lines in cul-de-sacs shall be equal to the right-of-way width or 45 feet, whichever is greater, and shall have a minimum radius of 35 feet to the edge of pavement and/or a radius of 37.5 feet to the back of the curb unless otherwise specified by the Director.

E. Street Grading: Earth slopes in cuts or embankment sections shall not be steeper than two (2) feet horizontal to one (1) foot vertical unless steeper slopes have been recommended by a licensed civil engineer in a report which shall be filed with and approved by the Director of Public Works.

F. Street Intersections:

1. All streets shall intersect as nearly as possible at right angles.
2. Streets entering on opposite sides of any given street shall have their centerlines directly opposite or shall be offset by at least 150 feet.

MINIMUM DESIGN STANDARDS FOR COUNTY ROADS

Design Feature	Traffic (ADT) Topography	Under 100		100-400		400-1000		1000-4000		4000-5000		Over 5000	
		Mini- mum	Desir- able	Mini- mum	Desir- able	Mini- mum	Desir- able	Mini- mum	Desir- able	Mini- mum	Desir- able	Mini- mum	Desir- able
Minimum Design Speed	Flat	40	50	45	55	50	60	60	70	60	70	60	70
	Rolling	30	30	35	45	40	50	50	60	50	60	50	60
	Mountainous	20	25	25	35	30	40	40	50	40	50	40	50
Radii (Ft.) (Min. & Desir- able Min.)	Flat	400	650	500	850	650	1000	1000	1500	1000	1500	1000	1500
	Rolling	275	400	350	525	400	650	650	1000	700	1000	800	1000
	Mountainous	100	250	150	325	300	400	400	650	500	650	600	700
Grade (%) (Max. & Desir- able Max.)	Flat	7	4	7	5	6	5	4	3	3	3	3	2
	Rolling	* 12	6	10	7	8	6	6	5	6	5	6	4
	Mountainous	* 15	10	* 12	9	10	7	7	6	7	6	6	5
Non-Passing Sight Distance (Ft.)	Flat	275	350	315	415	350	475	475	600	475	600	475	600
	Rolling	250	275	240	315	275	350	350	475	350	475	350	475
	Mountainous	125	200	165	240	200	275	275	350	275	350	275	350
R/W Width (Ft.)		60	60	60	60	60	80	60	80	80	100	80	100
Roadbed Width (Ft.)													
Surface Width (Ft.)													
Thickness Base & Surface													
Minimum Bridges Clear Width (Ft.)		24	26	26	30	30	52	30	52	52	52	52	52
Vertical Clearance (Ft.)		14.5	15	14.5	15	14.5	15	15	18	18	18	18	18
Design Load (A.A.S.H.O.)		H-20	H-20	H-20	H-20	H-20	H-20	H-20	H-20	H-20	H-20	H-20	H-20

*Grades Over 10% Require Approval By The Director

MONO COUNTY	
DESIGN STANDARDS	
DRAWN BY: F.P.C.	DATE: 5-81
APPROVED:	PUBLIC WORKS DEPT.

OTHER REQUIREMENTS

Street Name Signs: The subdivider shall furnish and install one street name sign per intersection on county maintained roads in accordance with the detail provided by the Public Works Department.

Snow Stakes: The subdivider shall furnish and install standard orange metal snow stakes twelve feet in length, for new roads within the subdivision on which the county is to provide snow removal when the subdivision is above elevation of 6,000 feet. The snow stakes shall be provided at the rate of 100 per mile of road to be plowed.

Additional Rights-of-Way: The County may require additional rights-of-way to accommodate traffic, parking, or bus stops. The Mono County Transportation Commission or the Planning Commission may require additional rights-of-way for non-vehicular traffic, i.e., bikeway, equestrian path, bus stops, if the right-of-way is shown on an adopted plan.

APPENDIX A

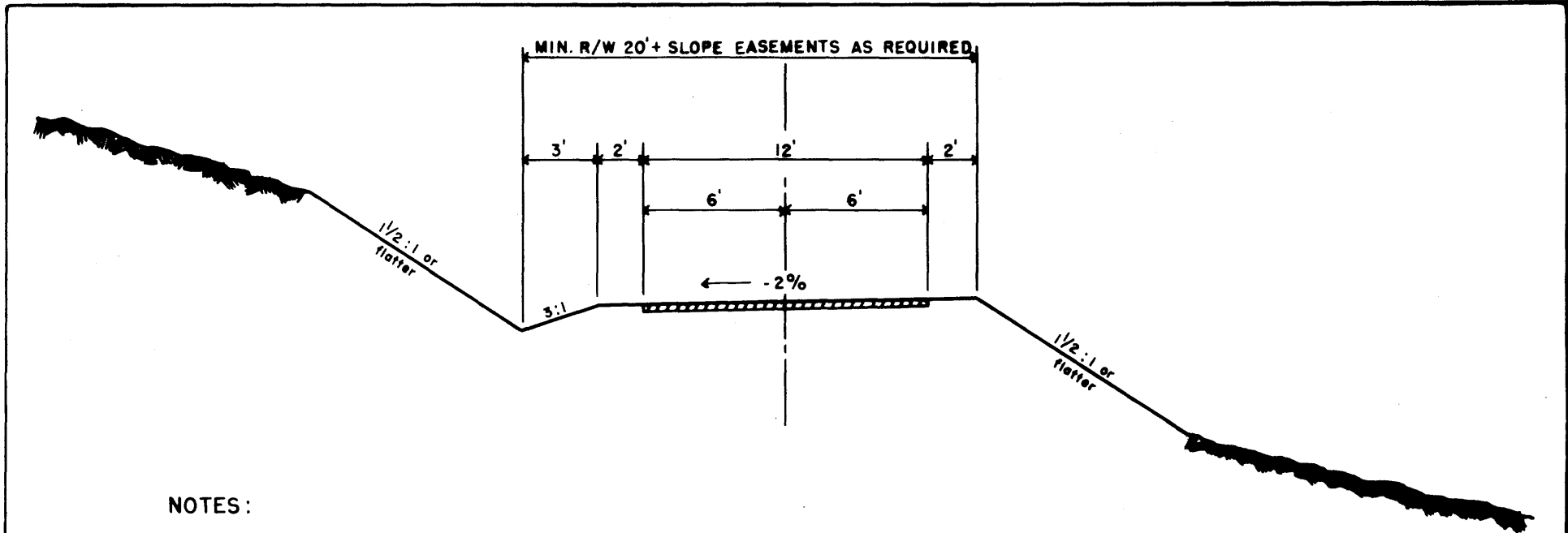

NOTES:

1. PRIVATELY OWNED AND/OR MAINTAINED ROAD
2. SERVES 4 OR LESS RESIDENTIAL LOTS
1/3 ACRE OR GREATER IN AREA
3. MAXIMUM ROAD GRADE LESS THAN 7%
4. ROAD SECTION SHALL BE A MINIMUM
OF 4" CL-2 AGGREGATE BASE.

PLATE NO. 1

MONO COUNTY	
TYPICAL SECTION RESIDENTIAL DRIVE CLASS I	
DRAWN BY: LDR	DATE: 5-81
APPROVED:	PUBLIC WORKS DEPT.

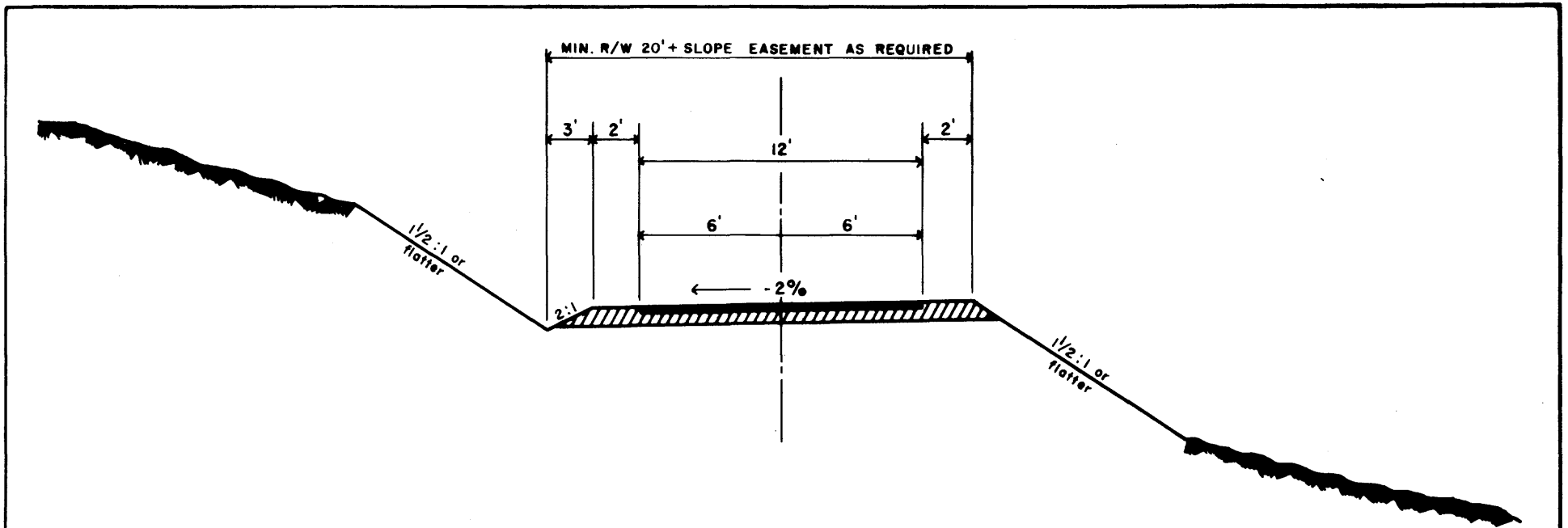

NOTES:

1. PRIVATELY OWNED AND/OR MAINTAINED ROAD
2. SERVES 4 OR LESS RESIDENTIAL LOTS
1/3 ACRE OR GREATER IN AREA
3. REQUIRED WHEN MAXIMUM ROAD GRADE
EXCEEDS 7%
4. ROAD SECTION SHALL BE A MINIMUM OF
4" CL-2 AGGREGATE BASE WITH 2" A.C.

PLATE NO. 2

MONO COUNTY	
TYPICAL SECTION RESIDENTIAL DRIVE CLASS II	
DRAWN BY: LDR	DATE: 5-81
APPROVED:	PUBLIC WORKS DEPT.

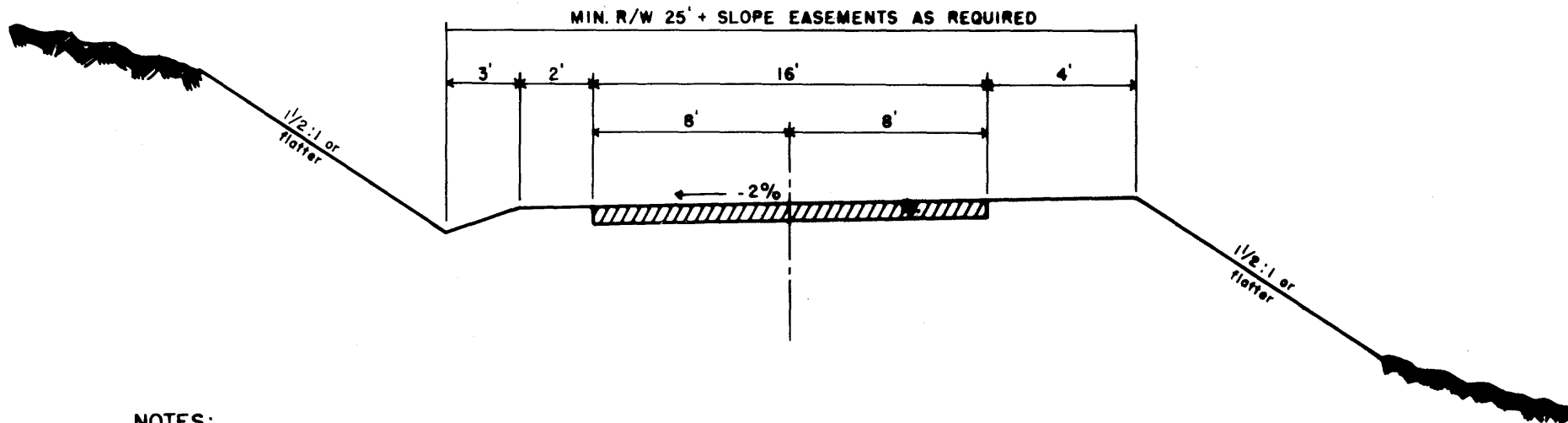

NOTES:

1. PRIVATELY OWNED AND/OR MAINTAINED ROAD
2. SERVES 10 OR LESS RESIDENTIAL LOTS
1/3 ACRE OR GREATER IN AREA
3. MAXIMUM ROAD GRADE LESS THAN 7%
4. ROAD SECTION SHALL BE A MINIMUM
OF 4" CL-2 AGGREGATE BASE

PLATE NO. 3

MONO COUNTY	
TYPICAL SECTION RESIDENTIAL DRIVE CLASS III	
DRAWN BY: LDR	DATE: 5-81
APPROVED:	PUBLIC WORKS DEPT.

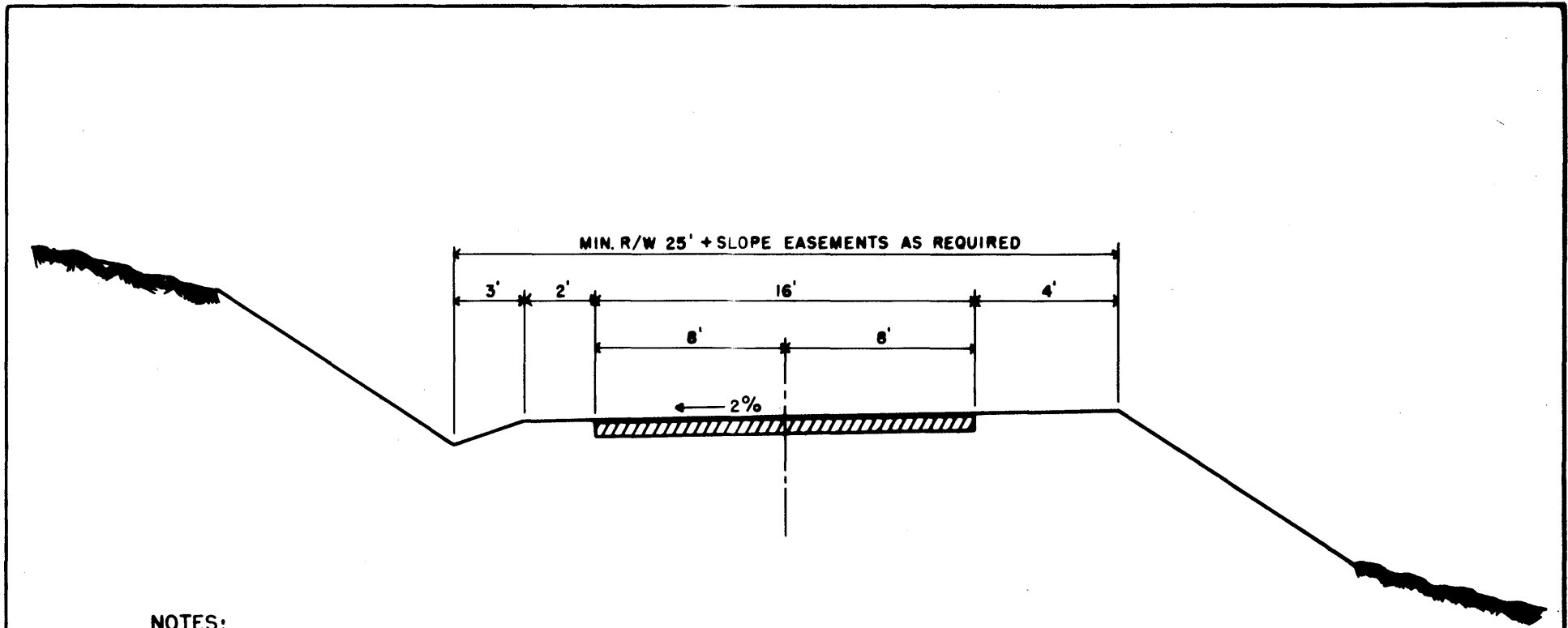

NOTES:

1. PRIVATELY OWNED AND/OR MAINTAINED ROAD
2. SERVES 10 OR LESS RESIDENTIAL LOTS
1/3 ACRE OR GREATER IN AREA
3. REQUIRED WHEN MAXIMUM ROAD GRADE
EXCEEDS 7% UP TO 15% MAX.
4. ROAD SECTION SHALL BE A MINIMUM OF
4" CL-2 AGGREGATE BASE WITH 2" A.C.

PLATE NO. 4

MONO COUNTY	
TYPICAL SECTION RESIDENTIAL DRIVE CLASS IV	
DRAWN BY: LDR	DATE: 5-81
APPROVED:	PUBLIC WORKS DEPT.

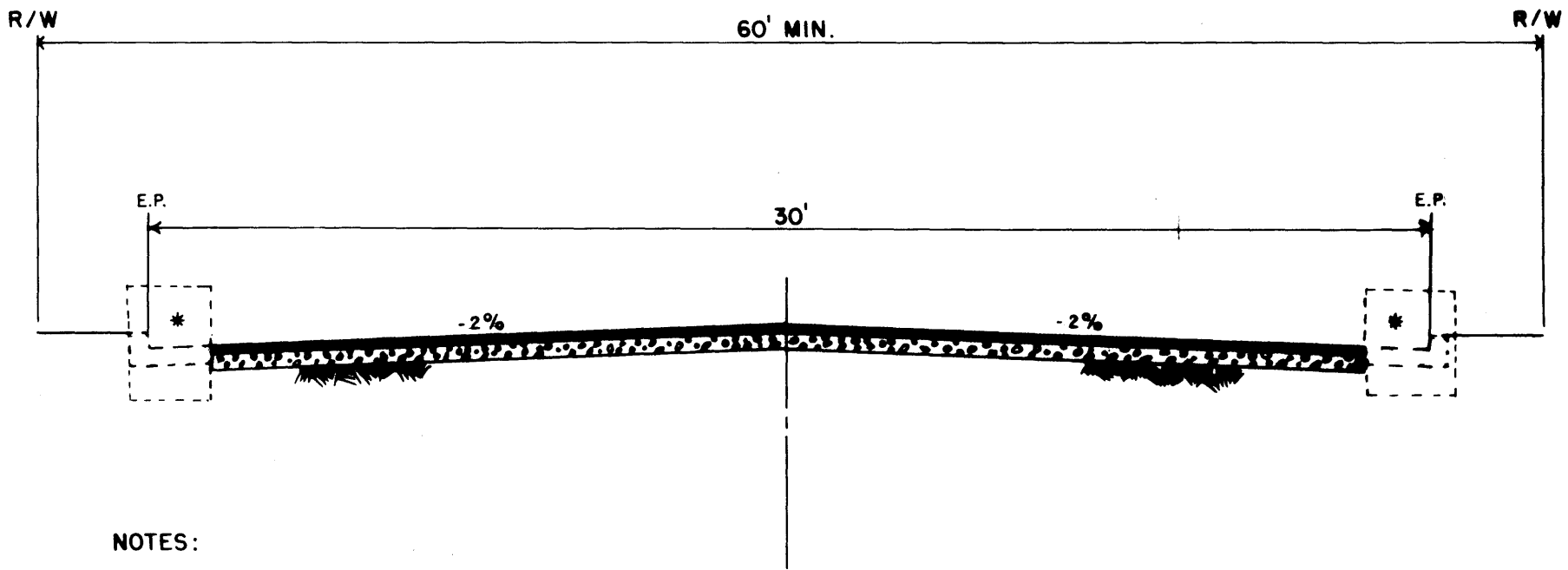

NOTES:

1. MAY BE COUNTY MAINTAINED ROAD
 2. SERVES ANY NUMBER OF RESIDENTIAL LOTS
 3. ROAD SECTION SHALL BE 0.25' A.C. WITH SUFFICIENT CL-2 AGGREGATE BASE TO ACCOMMODATE A T.I. OF 6.5 MIN.
- * REFER TO PLATE 13 FOR ALTERNATIVE DRAINAGE DETAILS

PLATE NO. 5

MONO COUNTY	
MAMMOTH	
TYPICAL SECTION	
RESIDENTIAL	
DRAWN BY: LDR	DATE: 5-81
APPROVED:	PUBLIC WORKS DEPT.

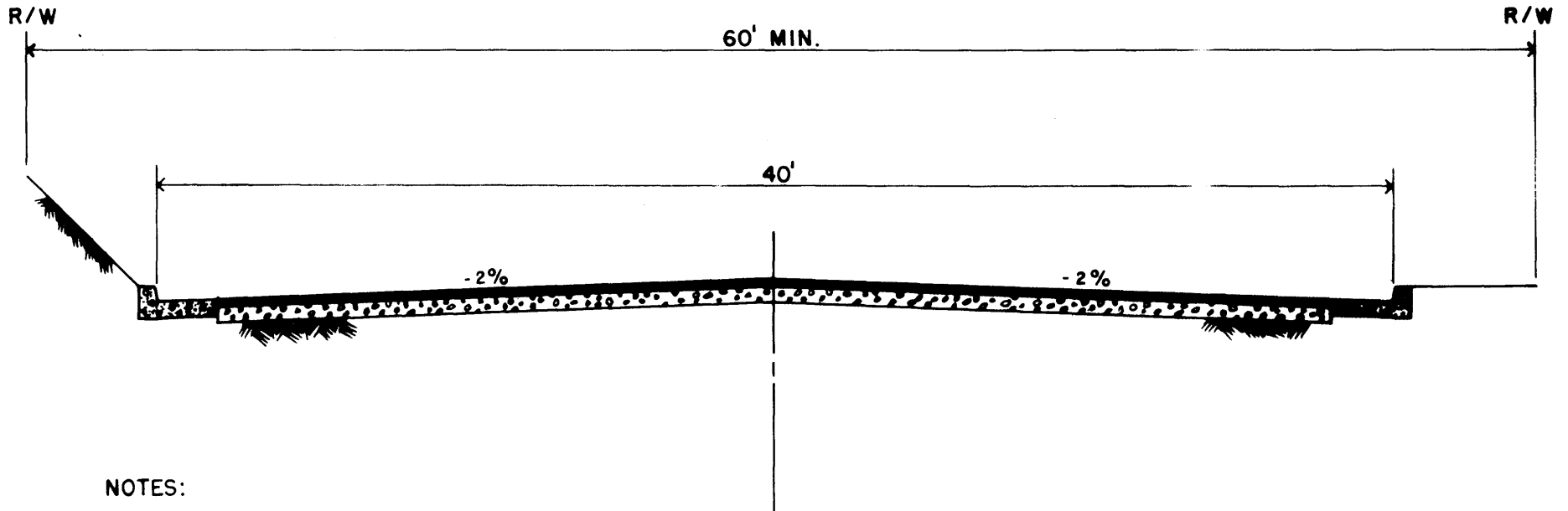

NOTES:

1. MAY BE COUNTY MAINTAINED ROAD
2. SERVES AS COLLECTOR/COMMERCIAL AREA ROAD WHEN ARTERIAL IS NOT REQUIRED
3. ROAD SECTION SHALL BE 0.25' A.C. MIN. WITH SUFFICIENT CL-2 AGGREGATE BASE TO ACCOMMODATE A T.I. OF 8.5 MIN.

PLATE NO. 8

MONO COUNTY	
MAMMOTH	
TYPICAL SECTION	
COLLECTOR/COMMERCIAL	
DRAWN BY LDR	DATE: 5-81
APPROVED	PUBLIC WORKS DEPT.

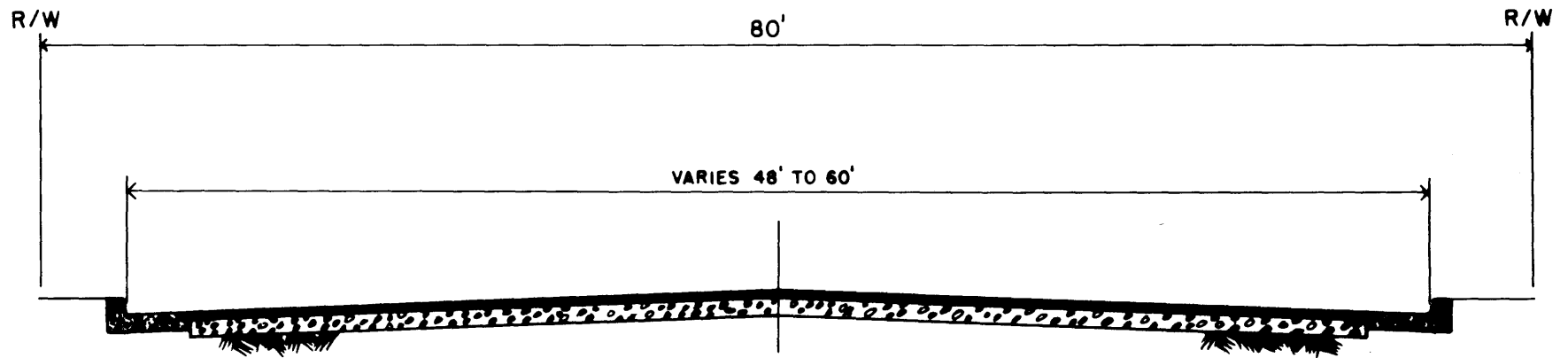

NOTES:

1. SHALL BE COUNTY MAINTAINED ROAD WITH ARTERIAL DESIGNATION
2. ROAD SECTION SHALL BE 0.25' A.C. WITH SUFFICIENT CL-2 AGGREGATE BASE TO ACCOMODATE A T.I. OF 8.5 OR GREATER AS DETERMINED BY THE DEPARTMENT OF PUBLIC WORKS.

PLATE NO. 7

MONO COUNTY	
MAMMOTH	
TYPICAL SECTION	
ARTERIAL	
DRAWN BY: LDR	DATE: 5-81
APPROVED:	PUBLIC WORKS DEPT.

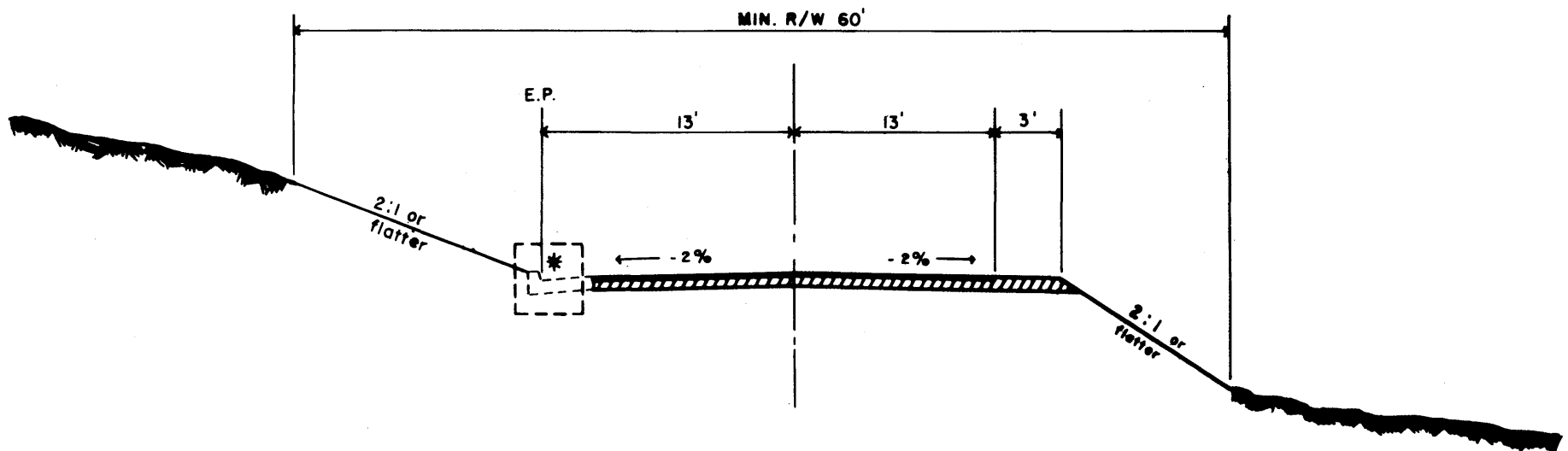

NOTES:

1. MAY BE COUNTY MAINTAINED ROAD
 2. SERVES ANY NUMBER OF RESIDENTIAL LOTS
1/3 ACRE OR GREATER IN AREA
 3. ROAD SECTION SHALL BE 0.25' A.C. WITH
SUFFICIENT CL-2 AGGREGATE BASE TO
ACCOMMODATE A T.I. OF 6.5 MIN.
- * SEE PLATE 13 FOR ALTERNATIVE
DRAINAGE DETAILS

PLATE NO. 8

MONO COUNTY	
TYPICAL SECTION RURAL SUBDIVISION STANDARD COUNTY ROAD	
DRAWN BY: LDR	DATE: 5-81
APPROVED:	PUBLIC WORKS DEPT.

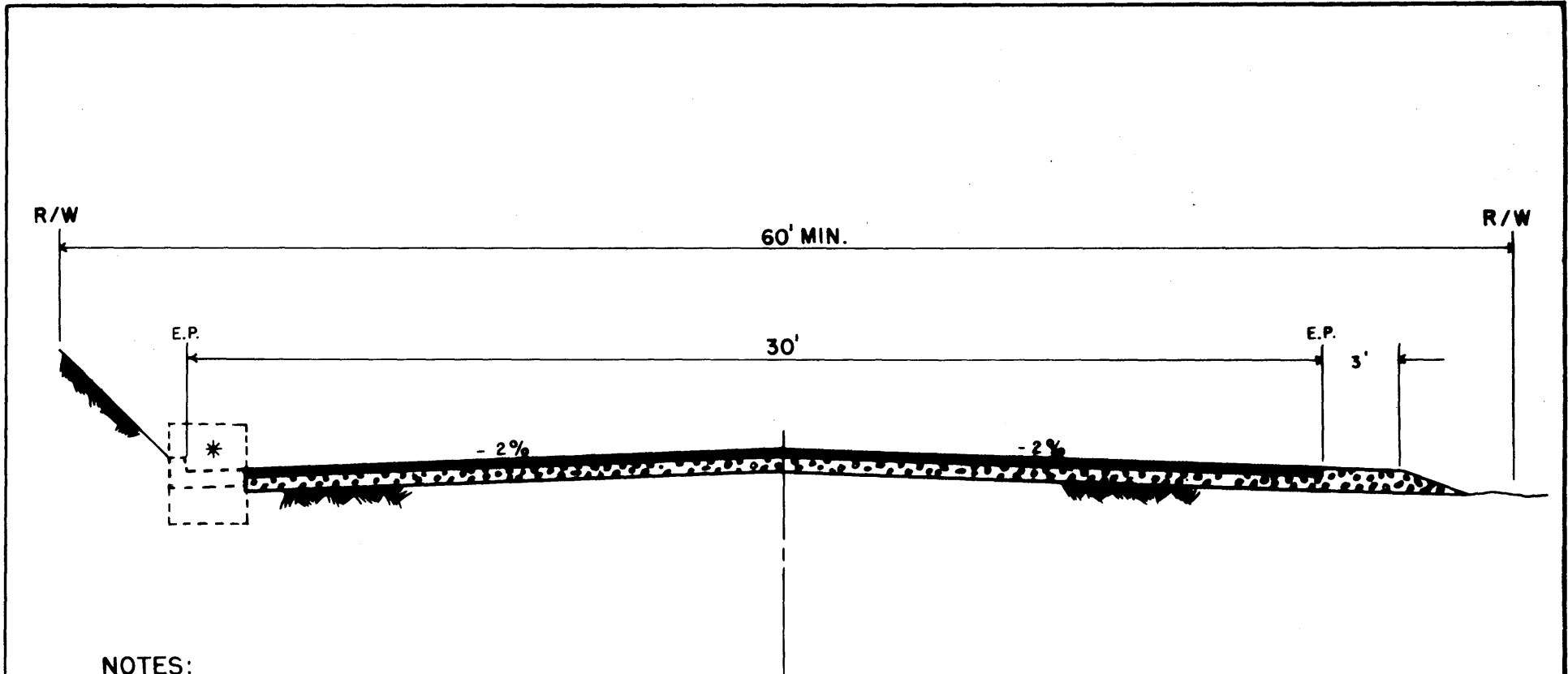

NOTES:

1. MAY BE COUNTY MAINTAINED ROAD
2. SERVES ANY NUMBER OF RESIDENTIAL LOTS LESS THAN 1/3 ACRE IN AREA
3. ROAD SECTION SHALL BE 0.25 A.C. MIN. WITH SUFFICIENT CL-2 AGGREGATE BASE TO ACCOMMODATE A T.I. OF 6.5 MIN.

* REFER TO PLATE 13 FOR ALTERNATIVE DRAINAGE DETAILS .

PLATE NO. 9

MONO COUNTY	
TYPICAL SECTION RESIDENTIAL STANDARD COUNTY ROAD	
DRAWN BY: LDR	DATE: 5-81
APPROVED:	PUBLIC WORKS SEPT.

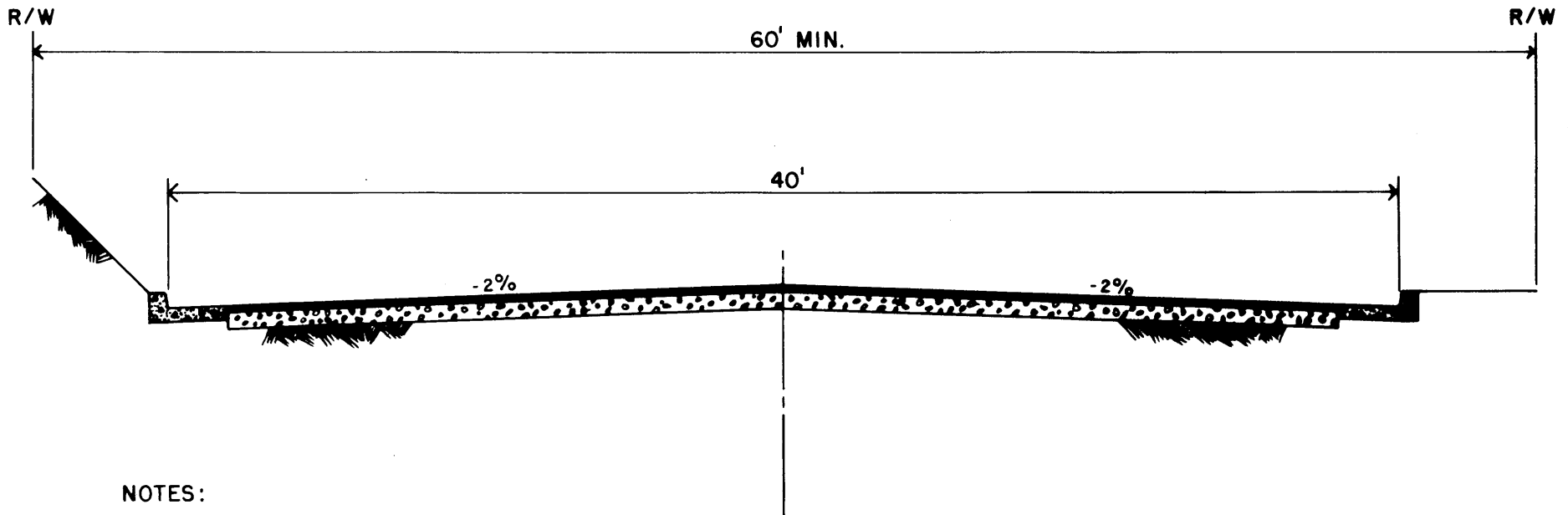

NOTES:

1. SHALL BE COUNTY MAINTAINED ROAD
2. SERVES AS ARTERIAL/COMMERCIAL AREA ROAD
3. ROAD SECTION SHALL BE 0.25' A.C. MIN. WITH SUFFICIENT CL-2 AGGREGATE BASE TO ACCOMMODATE A T.I. OF 8.5

PLATE NO. 10

MONO COUNTY	
TYPICAL SECTION ARTERIAL/COMMERCIAL	
STANDARD COUNTY ROAD	
DRAWN BY: LDR	DATE: 5-81
APPROVED:	PUBLIC WORKS DEPT.

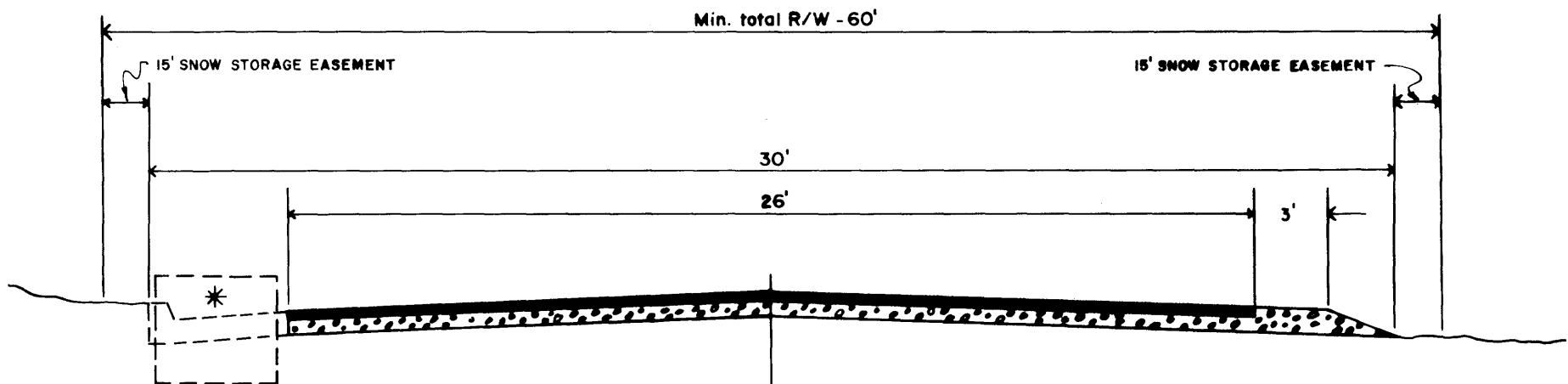

NOTES:

1. MAY BE COUNTY MAINTAINED ROAD
 2. SERVES ANY NUMBER OF RESIDENTIAL LOTS, AND FUNCTIONS AS RESIDENTIAL COLLECTOR
 3. ROAD SECTION SHALL BE 0.25' A.C. WITH SUFFICIENT CL-2 AGGREGATE BASE TO ACCOMMODATE A T.I. OF 6.5 MIN.
- * REFER TO PLATE 13 FOR ALTERNATIVE DRAINAGE DETAILS

PLATE NO. 11

MONO COUNTY	
JUNE LAKE	
TYPICAL SECTION COLLECTOR/RESIDENTIAL	
DRAWN BY: LDR	DATE: 5-81
APPROVED:	PUBLIC WORKS DEPT.

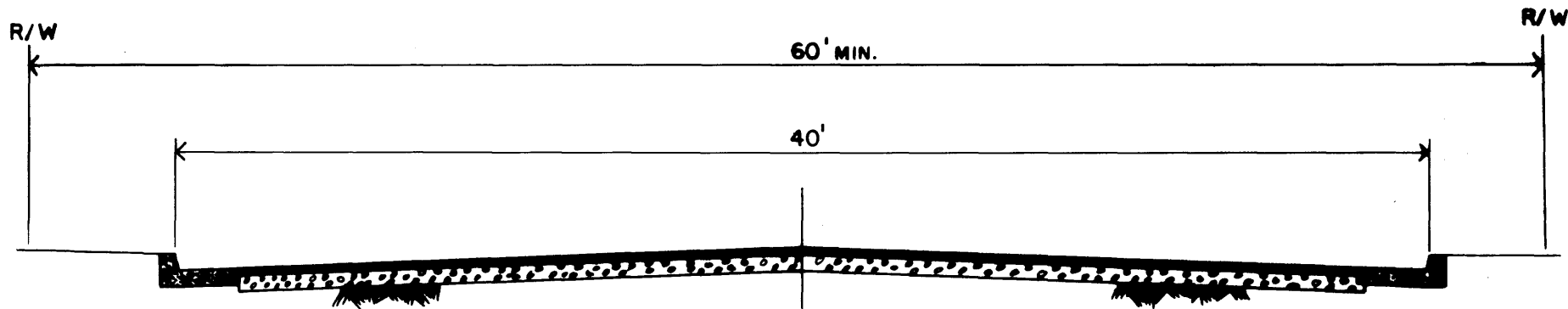

NOTES:

1. SHALL BE COUNTY MAINTAINED ROAD
2. SERVES AS ARTERIAL / COMMERCIAL AREA ROAD
3. ROAD SECTION SHALL BE 0.25' A.C. MIN. WITH SUFFICIENT CL-2 AGGREGATE BASE TO ACCOMMODATE A T.I. OF 8.5 MIN.

PLATE NO. 12

MONO COUNTY	
JUNE LAKE	
TYPICAL SECTION ARTERIAL / COMMERCIAL	
DRAWN BY: F.P.C.	DATE: 5-81
APPROVED:	PUBLIC WORKS DEPT.

ALTERNATE PAVED DITCH SECTION

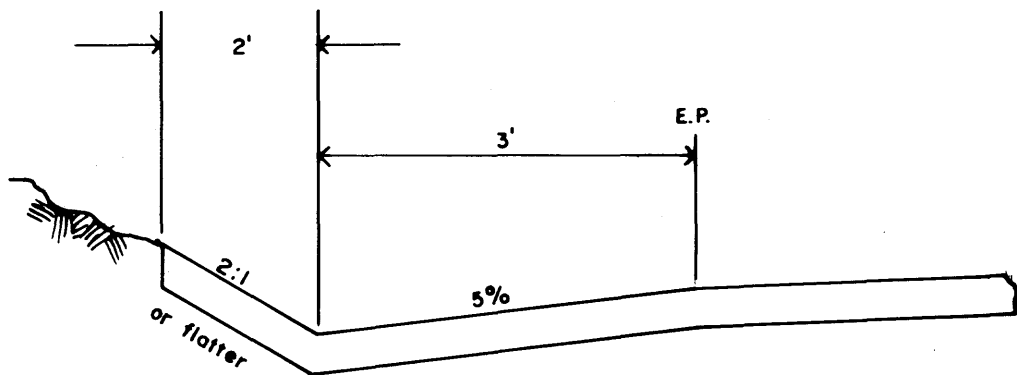

ALTERNATE A.C. DIKE

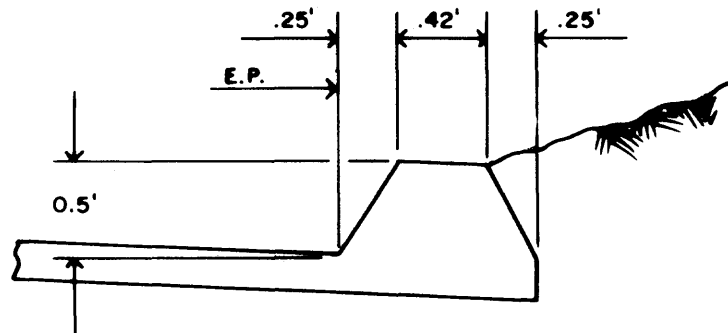

CURB & GUTTER

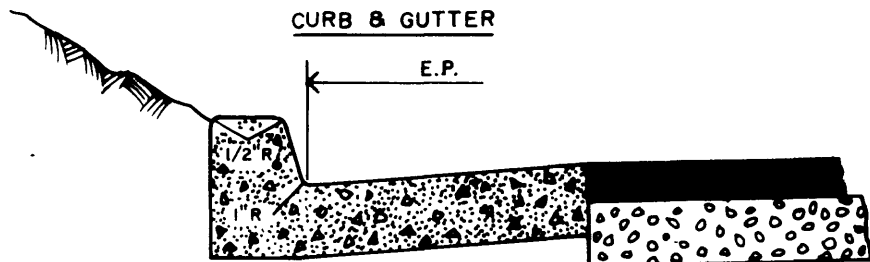

PLATE NO. 13

MONO COUNTY	
ROADSIDE DRAINAGE ALTERNATIVES	
DRAWN BY: LDR	DATE: 8-01
APPROVED:	PUBLIC WORKS DEPT.

Due to the many variable conditions encountered in the design of curbed street connections, it is impractical to establish a standard street curb return. In each case the radius should be as large as practical. In all cases it should accommodate the commercial design vehicle, taking into account any shoulder or parking strip being provided.

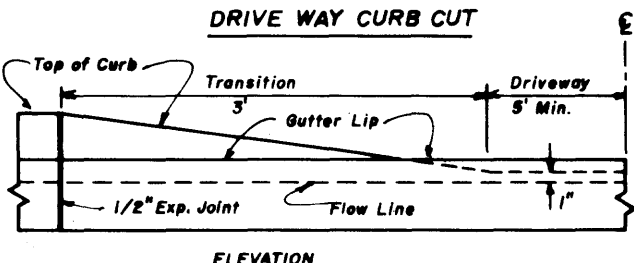
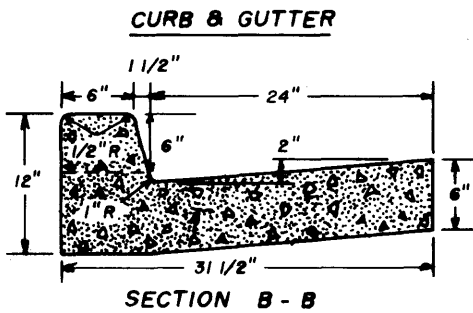
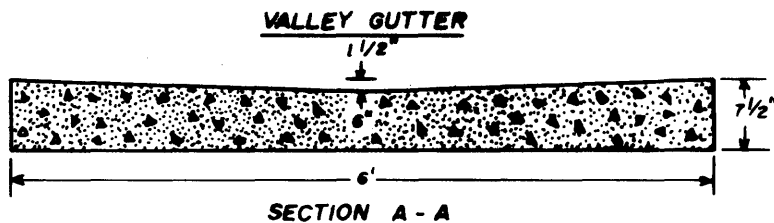
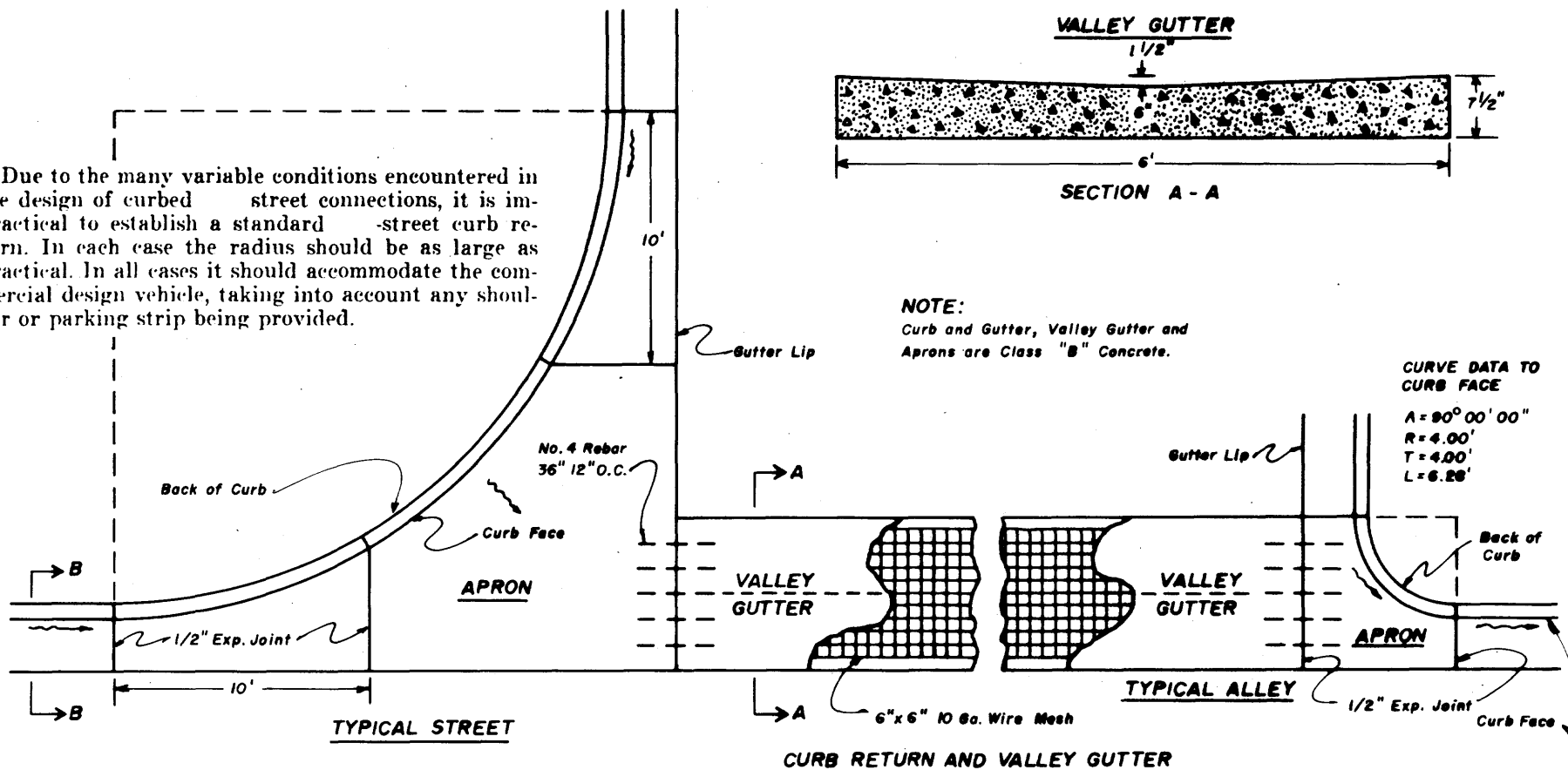

PLATE NO. 14

MONO COUNTY	
CURB AND GUTTERS	
DRAWN BY: LDR	DATE: 5-81
APPROVED:	PUBLIC WORKS DEPT.

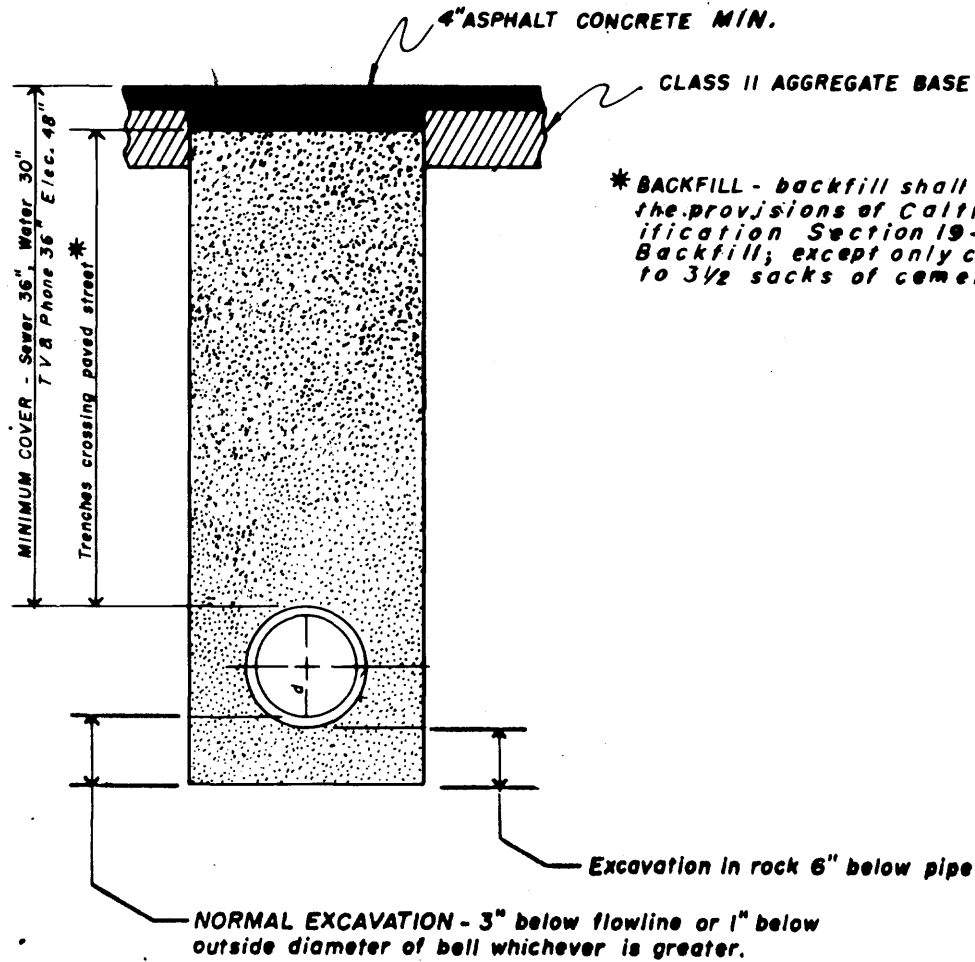

PLATE NO. 15

MONO COUNTY

TRENCH BACKFILL

DRAWN BY: LDR

DATE: 5-81

APPROVED:

PUBLIC WORKS DEPT.

Typical Valley Gutter



Typical Pipe Section

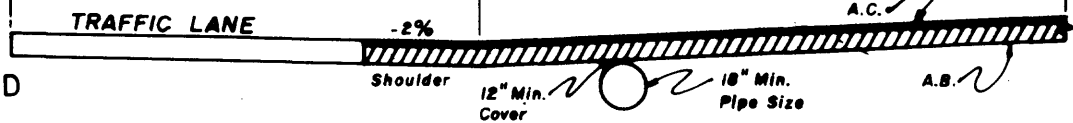

PUBLIC ROAD W/TAPERS

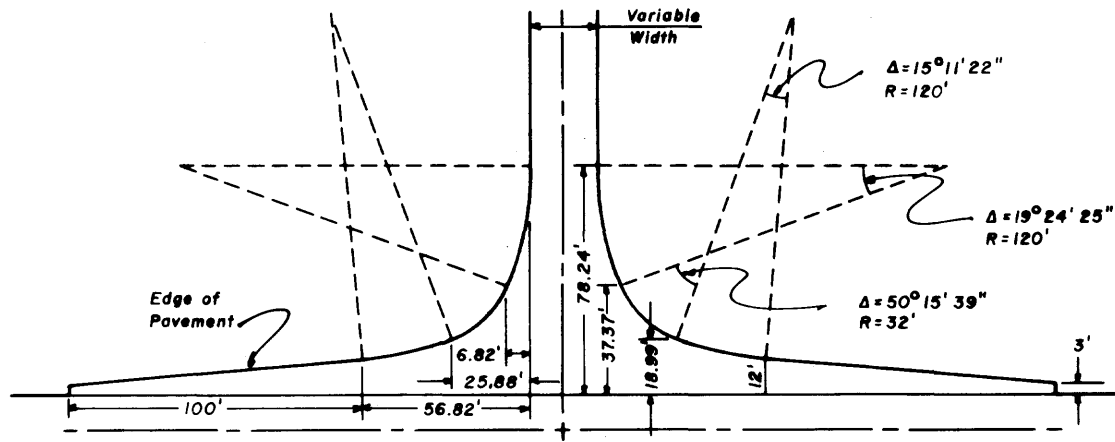

PRIVATE ROAD / PUBLIC ROAD W/O TAPERS

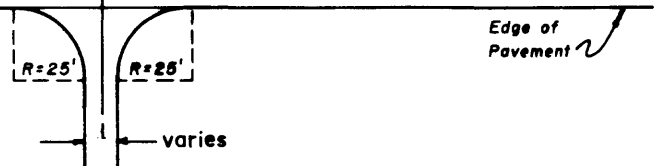

PLATE NO. 16

MONO COUNTY

ROADWAY CONNECTIONS

DRAWN BY: LDR	DATE: 5-81
APPROVED:	PUBLIC WORKS DEPT.

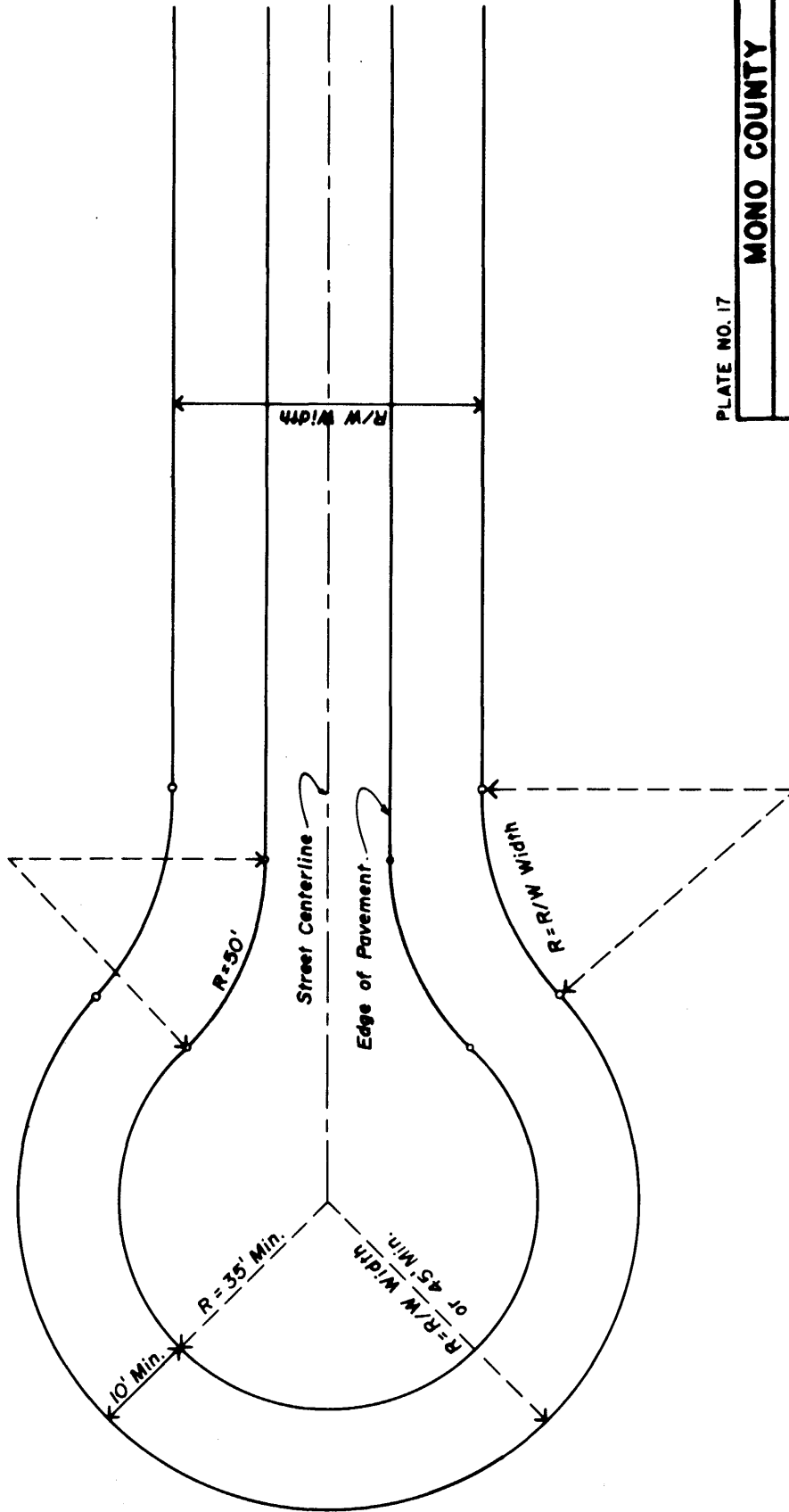

PLATE NO. 17

MONO COUNTY

CUL - DE - SAC

DRAWN BY: LDR

DATE: 5-01

APPROVED:

PUBLIC WORKS DEPT.

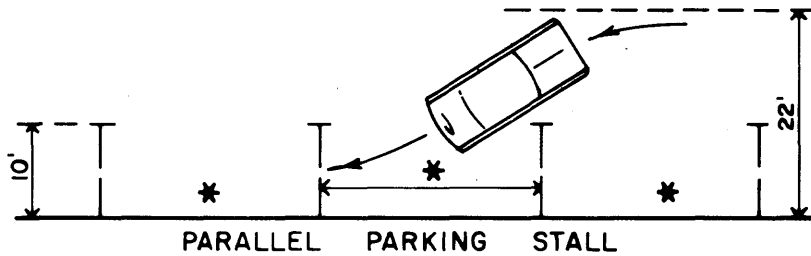

PARALLEL PARKING STALL

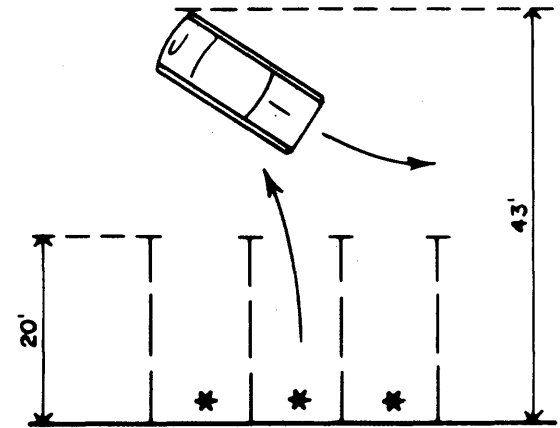

RIGHT ANGLE PARKING STALL

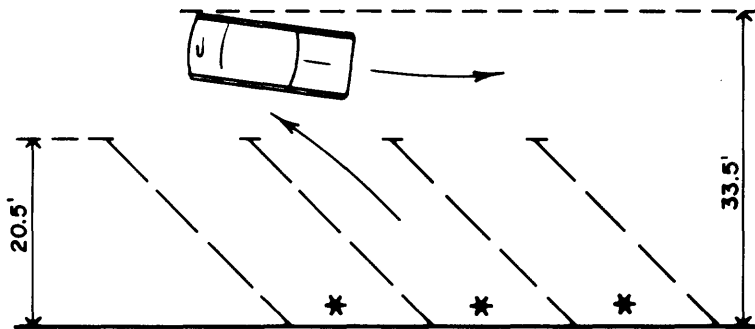

45° ANGLE PARKING STALL

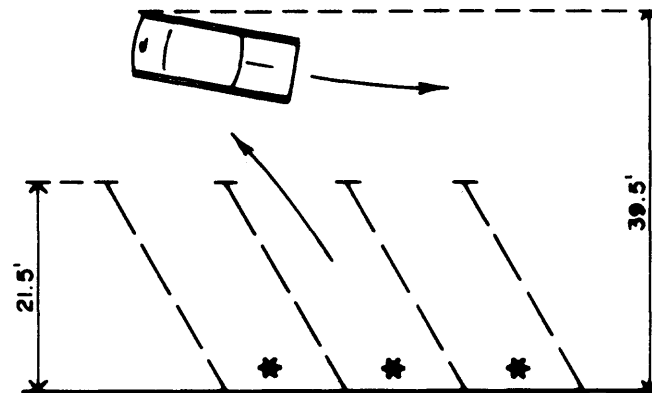

60° ANGLE PARKING STALL

10' WIDTH STALL

Angle of Parking at Curb	Width of Street Used When Parked	Width Needed For Parking Plus Maneuvering	Length of Curb Per Car *	Cars Parked Per 100 feet
Parallel	10.0	22.0	23.0	4.3
45° Degrees	20.0	33.5	14.1	7.1
60° Degrees	21.5	39.5	11.5	8.7
90° Degrees	19.0	43.0	10.0	10.0

Source : "Traffic Engineering Handbook" - Third Edition - Chapter XII - Page 477

PLATE NO. 18

MONO COUNTY

DESIGN AND LOCATION OF
PARKING FACILITIES

DRAWN BY: LDR

DATE: 5-81

APPROVED:

PUBLIC WORKS DEPT.

Asphaltic surface?

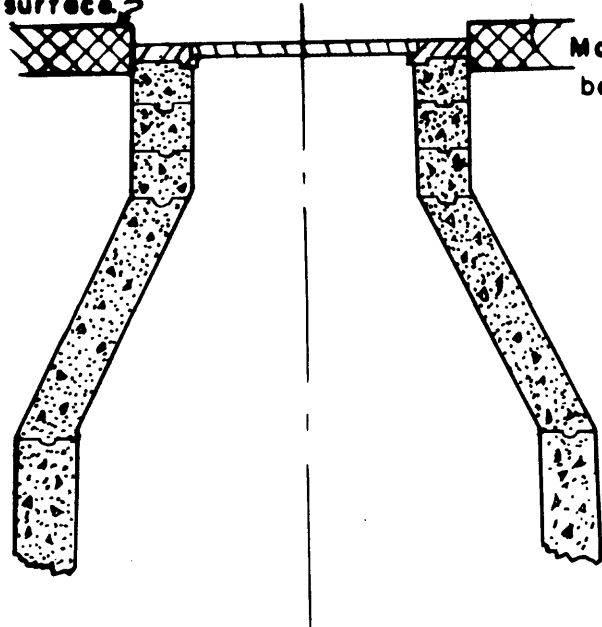

Manhole rim to be placed $\frac{1}{2}$ " below finished grade of pvmt.

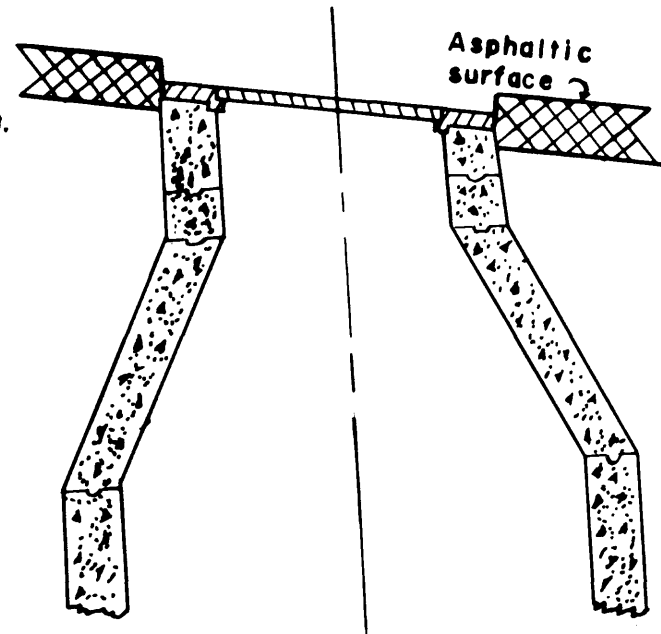

Asphaltic surface?

NOTE:

All utility boxes to be set $\frac{1}{2}$ " below and parallel to finished grade of pvmt.

PLATE NO. 19

MONO COUNTY

TYPICAL GRADE DETAIL FOR
MANHOLES, LAMP HOLES,
CLEAN-OUTS, SURVEY
MONUMENTS, ETC.

DRAWN BY: F.P.C.

DATE: 5-81

APPROVED:

PUBLIC WORKS DEPT.

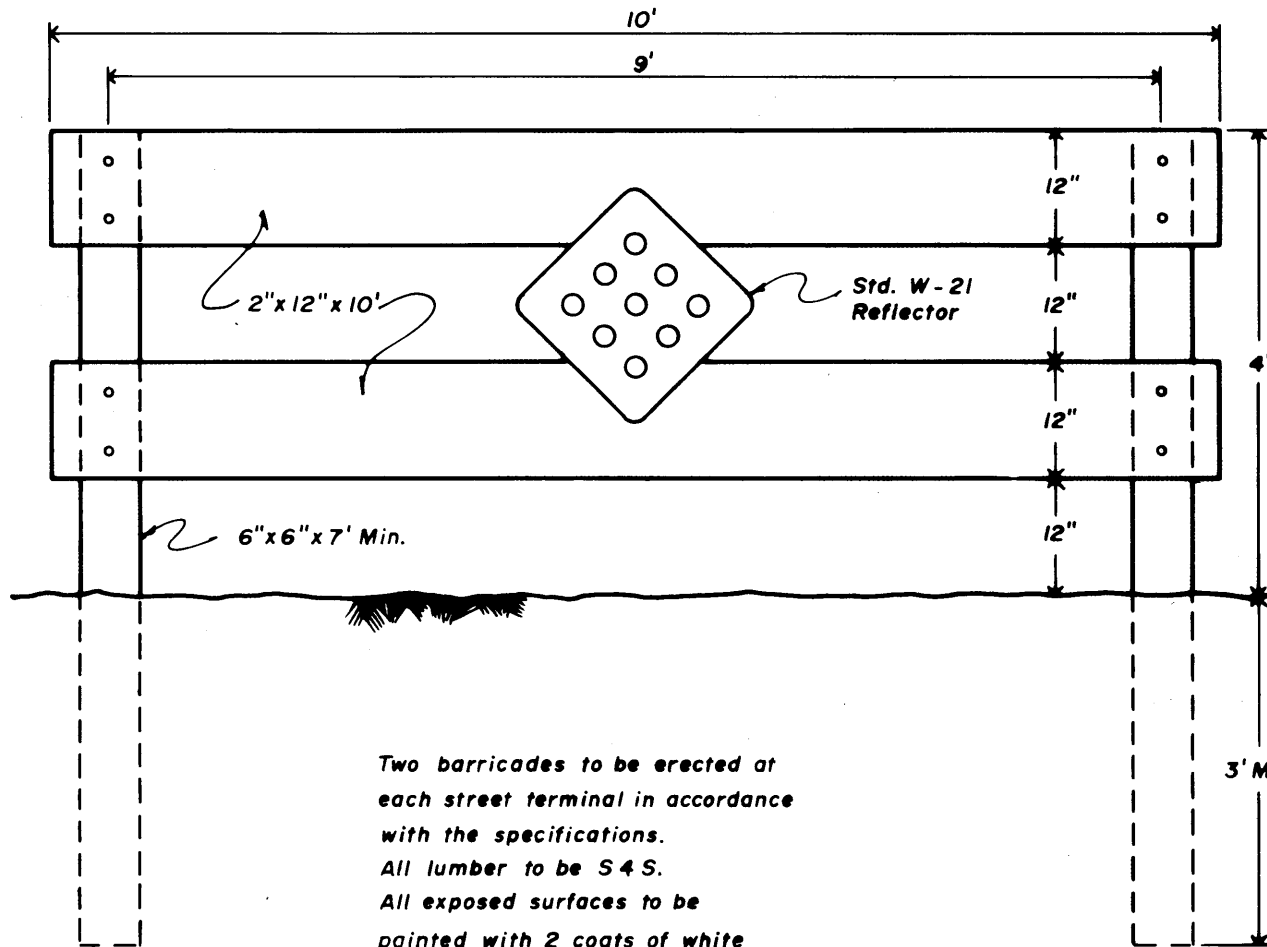

1/2" Carriage Bolts with
Cut Washers and Nut

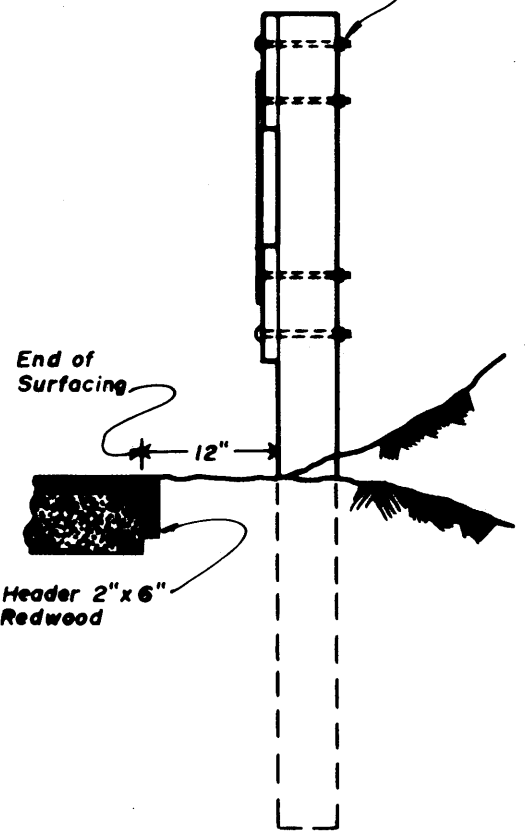

Two barricades to be erected at
each street terminal in accordance
with the specifications.
All lumber to be S 4 S.
All exposed surfaces to be
painted with 2 coats of white
paint conforming to Sec. 91-3.02
of State Specifications.

PLATE NO. 20

MONO COUNTY	
TIMBER BARRICADE	
DRAWN BY: LDR	DATE: 5-81
APPROVED:	PUBLIC WORKS DEPT.